

ECOFLOW

PRO

EcoFlow RIVER Pro | User Manual

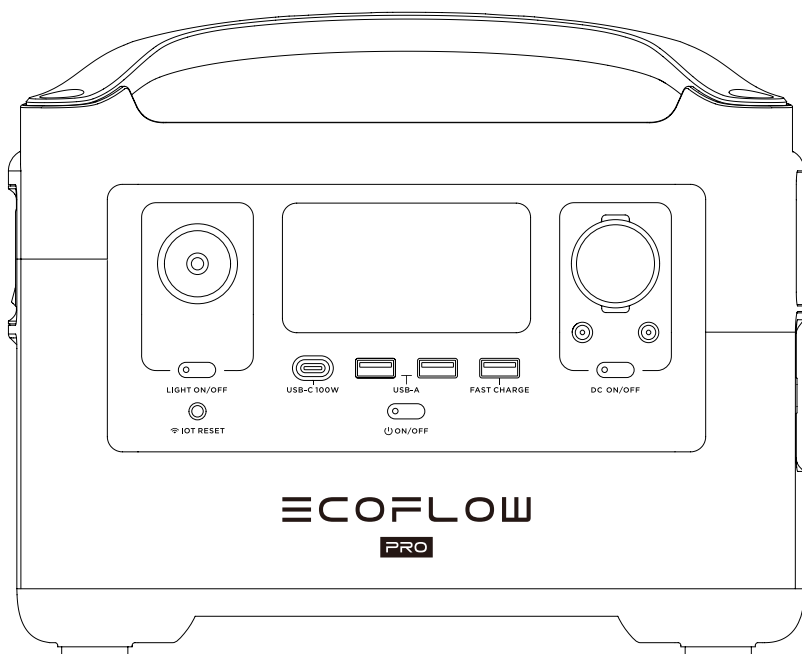

DISCLAIMER

Read all safety tips, warning messages, terms of use, and disclaimers carefully. Refer to the terms of use and disclaimer at <https://ecoflow.com/pages/terms-of-use> and stickers on the product before use. Users take full responsibility for all usage and operations. Familiarize yourself with the related regulations in your area. You are solely responsible for being aware of all relevant regulations and using EcoFlow products in a way that is compliant.

CONTENTS

1. Specifications	1
2. Safety Instructions	
2.1 Usage	2
2.2 Disposal Guide	3
3. Getting Started	
3.1 Product Details	4
3.2 LCD Screen	5
3.3 General Product Usage	5
3.4 AC Charging	7
3.5 Solar Charging	7
3.6 Car Charging	8
3.7 APP	8
3.8 X-Boost	9
3.9 Emergency Power Supply (EPS)	9
3.10 Extra Battery Connection	10
4. FAQs	11
5. Troubleshooting	12
6. What's In the Box	13
7. Storage & Maintenance	13

1. Specifications

General Info

Model	EF4 PRO
Net Weight	Approximately 16.8lbs (7.6kg)
Dimensions	11.4in x 7.3in x 9.3in(28.9 x 18.0 x 23.5 cm)
Capacity	720Wh 28.8V ^{DC}
Wi-Fi	Supported

Output Ports

AC (x2)	Pure Sine Wave, 600W total (Surge 1200W), 240V- 50Hz
Max Device(s) Power Supported by X-Boost	1800W
USB-A (x2)	5V ^{DC} =2.4A 12W Max, per port, 24W total
USB-A Fast Charge (x1)	5V ^{DC} =2.4A 9V ^{DC} =2A 12V ^{DC} =1.5A 18W Max, per port
USB-C (x1)	5/9/12/15/20V ^{DC} =5A 100W Max, per port
Car Charger(x1)	13.6V ^{DC} =10A, 136W Max
DC5521 Output (x2)	13.6V ^{DC} =3A, per port

* Car charger shares power with the DC5521 output port, offering a maximum output of 136W.

Input Ports

AC Charge	X-Stream Fast Charge 660W Max, 10A
AC Input Voltage	220-240V- 50Hz/60Hz, 10A
Solar Charger	10-25V ^{DC} =12A, 200W Max
Car Charger	Supports 12V Battery, 8A

Battery Info

Cell Chemistry	Lithium-ion
Cycle Life	800 cycles to 80%+ capacity
Protection	Over Voltage Protection, Overload Protection, Over Temperature Protection, Short Circuit Protection, Low Temperature Protection, Low Voltage Protection, Overcurrent Protection

Environmental Operating Temperature

Optimal Operating Temperature	20°C-30°C (68°F-86°F)
Discharge Temperature	-20°C-45°C (-4°F-113°F)
Charge Temperature	0°C-45°C (32°F-113°F)
Storage Temperature	-20°C-45°C(-4°F-113°F) (optimal: 20°C-30°C(68°F-86°F))

* Whether the product can be charged or discharged depends on the actual temperature of the battery pack.

2. Safety Instructions

2.1 Usage

1. Do not use the product near a heat source, such as a fire source or a heating furnace.
2. Avoid contact with any liquid. Do not immerse the product in water or get it wet. Do not use the product in rain or humid environments.
3. Do not use the product in an environment with strong static electricity/magnetic fields.
4. Do not disassemble the product in any way or pierce the product with sharp objects.
5. Avoid using wires or other metal objects that may result in a short circuit.
6. Do not use unofficial components or accessories. If you need to replace any components or accessories, please visit official EcoFlow channels to check relevant information.
7. When using the product, please strictly follow the operating environment temperature specified in this user manual. If the temperature is too high, it may result in a fire or explosion; if the temperature is too low, the product performance may be severely reduced, or the product may cease to work.
8. Do not stack any heavy objects on the product.
9. Do not lock the fan forcibly during use or place the product in an unventilated or dusty area.
10. Please avoid impact, falls, or severe vibrations when using the product. In case of a severe external impact, turn off the power supply immediately and stop using the product. Ensure the product is well fastened during transportation to avoid vibrations and impacts.
11. If you accidentally drop the product into water during use, please place it in a safe open area, and stay away from it until it is completely dry. The dried product should not be used again, and should be properly disposed of according to Section 2.2 below. If the product catches fire, we recommend that you use the fire extinguishers in the following order: water or water mist, sand, fire blanket, dry powder, and finally a carbon dioxide fire extinguisher.
12. Use a dry cloth to clean off dirt on the product ports.
13. Rest the product on a flat surface to avoid damages caused by the product falling over. If the product is overturned and severely damaged, turn it off immediately, place the battery in an open area, keep it away from combustible matter and people, and dispose of it in accordance with local laws and regulations.
14. Ensure that the product is kept out of reach of children and pets.
15. Please do not throw this product to the fire.
16. Please do not use it when you are in the low pressure area.
17. Store the product in a dry and ventilated place.
18. It is recommended to use moisture barrier bags in wet environments (for example, places by the sea or waterways) to prevent the product from getting soaked. If water is found inside the product, it must not be used or turned on again. Please take anti-electric shock measures before touching the product. Following this, place the product in a safe, waterproof and open area. Once complete contact EcoFlow Customer Service immediately.
19. This product is not recommended for powering medical emergency equipment related to personal safety, including but not limited to medical grade ventilators (hospital version CPAP: Continuous Positive Airway Pressure), artificial lungs (ECMO, Extracorporeal Membrane Please follow your doctor's instructions and consult with the manufacturer for restrictions on the use of the equipment. If used for general medical equipment, please be sure to monitor the power status to ensure that the power does not run out.

- 20.** When in use, power supply products will generate electromagnetic fields, which are likely to affect the normal operation of medical implants or personal medical equipment such as pacemakers, cochlear implants, hearing aids, defibrillators etc. If these types of medical equipment are being used, please contact the manufacturer to inquire about any restrictions on the use of such equipment. These measure are fundamental to ensure a safe distance between the medical implants (for example, pacemakers, cochlear implants, hearing aids, defibrillators etc.) and this product while in use.
- 21.** When the power supply is connected in normal mode to a refrigerator, power fluctuations may cause the power supply to automatically shut down. When connecting the power supply to a refrigerator that stores medicine, vaccines or other valuable items, it is recommended to set the AC output to "Always on" in the app. This helps support a continuous power supply and ensures a safe and efficient power consumption state.



This product is designated for separate collection at an appropriate collection point.

Do not dispose of as household waste.



IP20 For indoor use only

2.2 Disposal Guide

- 1.** If conditions permit, make sure that the battery is fully discharged before disposing it in a designated battery recycling bin. The product contains batteries with potentially dangerous chemicals, so it is strictly prohibited to dispose of it in ordinary trash cans. For more details, please follow the local laws and regulations on battery recycling and disposal.
- 2.** If the battery cannot be fully discharged due to a product failure, please do not dispose of the battery directly in the battery recycling box. In such case, you should contact a professional battery recycling company for further processing.
- 3.** Please dispose of over-discharged batteries that cannot be recharged.

3. Getting Started

3.1 Product Details

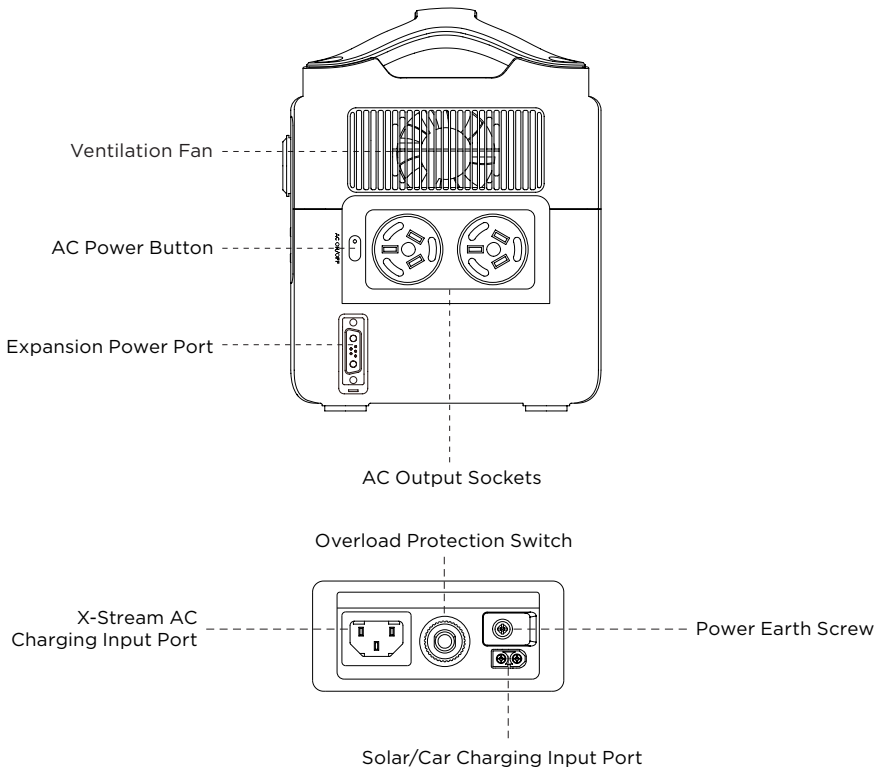
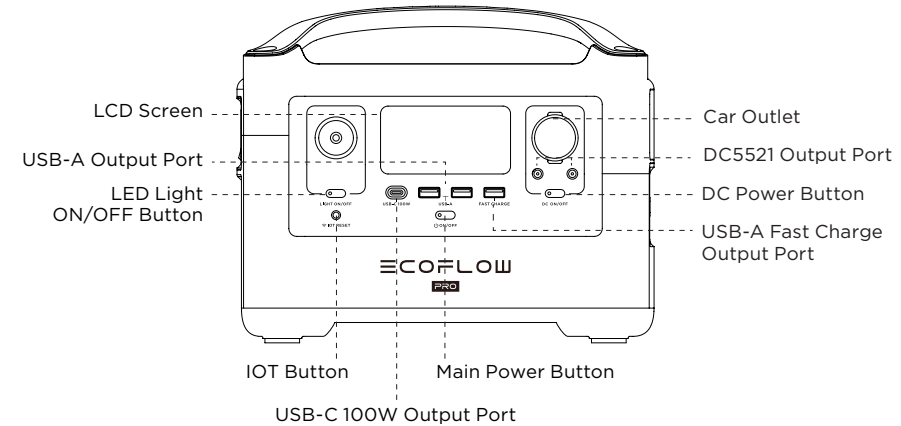

3.2 LCD Screen

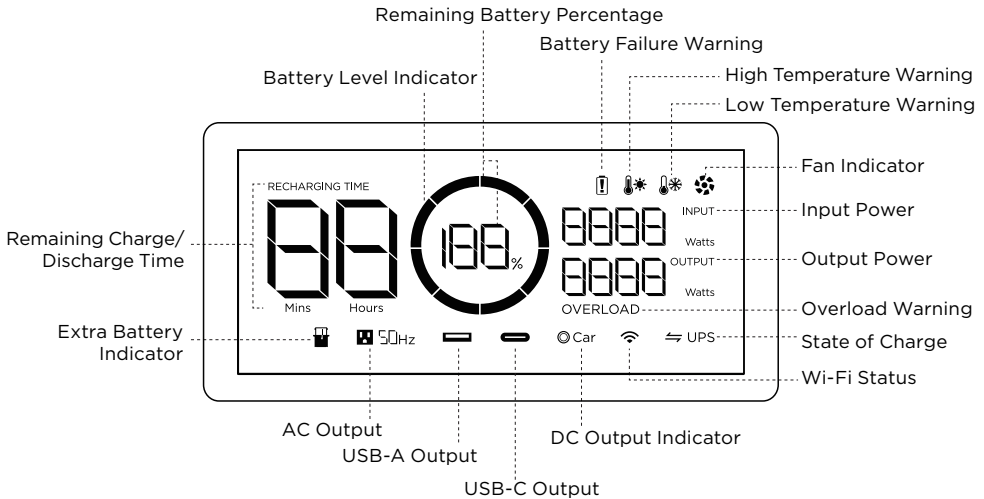

Battery Level Indicator: The indicator will repeatedly fill while charging. If product is at 0% charge, the indicator will flash to warn you.

Wi-Fi Status: After pressing the IOT button for 3 seconds, the Wi-Fi status will flash on the LCD screen which indicates that the product is ready for pairing. There're two ways to connect the product with the App, either directly connect to the product's hotspot or using the Internet. If the App is successfully connected to the product's hotspot, the icon will keep flashing; if it is successfully connected to the Internet, the icon will stay on.

* See Section 5 for more troubleshooting steps.

Note

WORKING MODE: (1) Charging (2) Discharging (3) Charging While Discharging

3.3 General Product Usage

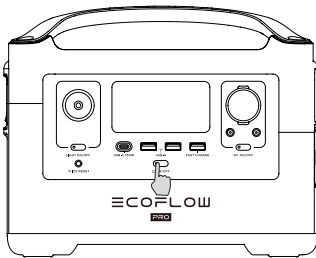

Short Press to Turn On

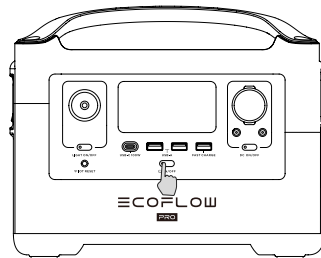

Long Press to Turn Off

Product On, Product Off, LCD Screen On

Short press the Main Power Button to turn on the product; the LCD Screen will light up and the battery level indicator icon will display.

The product enters sleep mode after 5 minutes of idle operation; the LCD Screen will automatically turn off. When the product senses any load change or operations, the LCD Screen will automatically light up. To turn the LCD Screen on or off, please short press the Main Power Button.

To power off the product, press and hold the Main Power Button.

The default product standby time is 2 hours. With other Power Buttons turned off and no other load access for 2 hours, the product will automatically shut down. The standby time can be set on the App.

DC Output Port

With the Main Power Button turned on, short press the DC Power Button to use the DC Output port. Short press the DC Power Button again to turn it off.

With the DC Power Button on, the product will not automatically shut down.

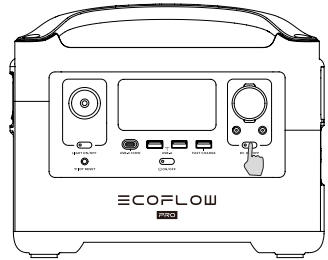

Short Press DC Power Button

AC Output Port

With the Main Power Button turned on, short press the AC Power Button to use the AC Output ports. Short press the AC Power Button again to turn it off.

The default standby time of the AC Output port is 12 hours. Without any load access for 12 hours, the AC Power Button will automatically turn off.

Please turn off AC power button when not in use to save power consumption.

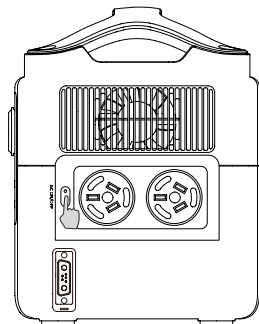

Short Press
AC Power Button

3.4 AC Charging

X-Stream is an AC fast charge technology that recharges your portable power station at the fastest speed possible. For slower, quieter charging, download the EcoFlow app and enable Slow Charging. The unit will shut down if the current from an AC source exceeds 10A for an extended period. The Overload Protection Switch will need to be pressed before powering the unit back on.

*Note: Please do not use this product when the AC input current exceeds 10A.

*Please do not charge and discharge at the same time when the AC power exceeds 600W.

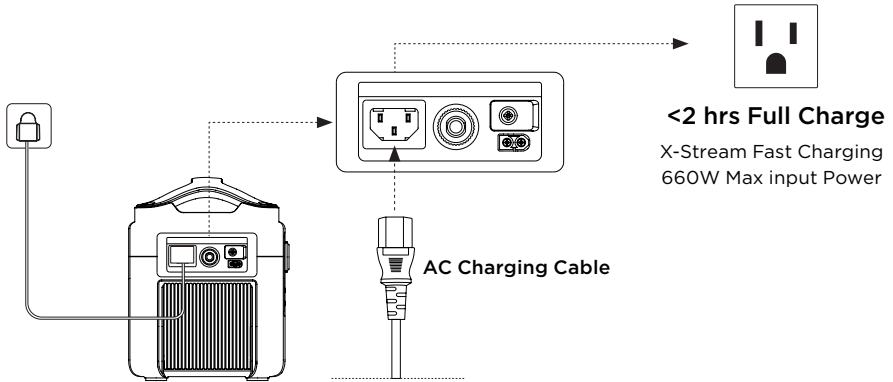

If the external flexible cord of this inverter is damaged, it shall be replaced by a special cord or assembly available from the manufacturer or its service agent.

Please use AC charging Cable for fast charging. EcoFlow takes no responsibilities for any consequences caused by failures to follow instructions, including but not limited to charging with AC charging Cable.

3.5 Solar Charging

Users can connect solar panels in series as shown in the figure to recharge the product.

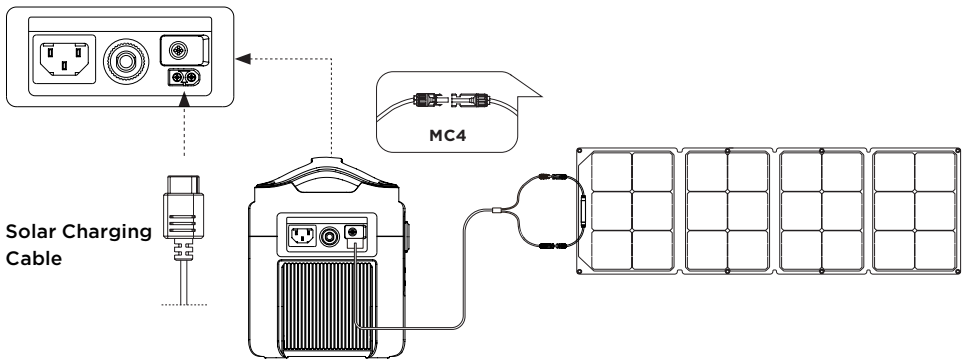

*Solar charging cable (MC4-XT60 adapter cable) is supplied separately.

When using an EcoFlow solar panel to charge the product, please follow the instructions that come with the solar panel.

Before connecting the solar panel, please ensure that the solar panel's output voltage is within voltage range to avoid product damage.

3.6 Car Charging

Users can recharge the product through the Car Charging Input Port. Please charge using the car charger after you've started the car to avoid failure to start due to insufficient car battery. In addition, please make sure that Car Charging Input Port and the Car Charging Cable are in good condition. EcoFlow takes no responsibilities for any losses or damages caused by failures to follow instructions.

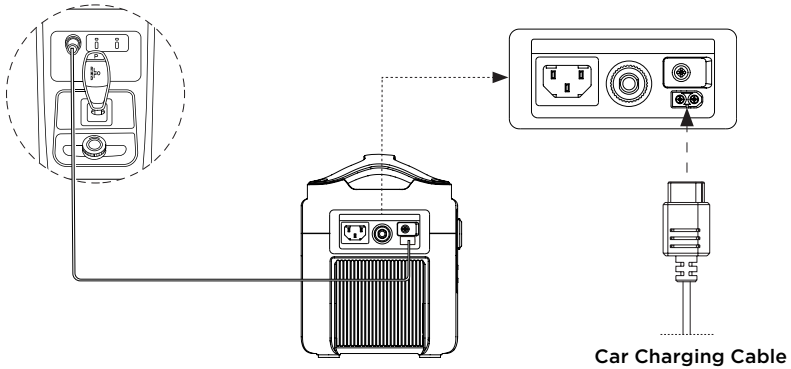

3.7 APP

The EcoFlow App gives users the ability to control and monitor EcoFlow power stations remotely. Read the EcoFlow App user guide and access the download link here:
<https://ecoflow.com/pages/ecoflow-app>

Privacy Policy

By using EcoFlow Products, Applications and Services, you consent to the EcoFlow Term of Use and Privacy Policy, which you can access via the "About" section of the "User" page on the EcoFlow App or on the official EcoFlow website at <https://ecoflow.com/pages/terms-of-use> and <https://ecoflow.com/pages/privacy-policy>



3.8 X-Boost

To avoid operation failure due to overload protection, the X-Boost feature will be automatically enabled when the total output exceeds the rated output power, which enables the product to power high wattage appliances at the rated output power.

X-Boost Tips:

1. X-Boost is enabled by default; you can enable or disable it in the EcoFlow App.
2. X-Boost is not available when the AC output is turned on in a recharging state (in bypass mode) and when X-Boost is disabled.
3. X-Boost is not applicable for all electrical appliances; it's incompatible with appliances with strict voltage requirements. Appliances with voltage protection (such as precise instruments) are not supported. X-Boost mode is more suitable for heating devices. Please conduct your own tests with your devices with X-Boost enabled.

3.9 Emergency Power Supply (EPS)

The product supports EPS. When you connect the grid power to the AC Input Port of the product through an AC Charging cable, you can power electrical devices through the AC Output Sockets (AC power will come from the grid and not the power station in this situation). In case of a sudden blackout, the product can automatically switch to the battery powered supply mode within 30ms. As a basic UPS function, this function does not support 0ms switching. Please do not connect the product to any device that requires 0ms UPS, such as data servers and workstations. Please test and confirm the compatibility before using the product. We recommend that you only charge one device at a time and avoid using multiple ones at the same time to avoid overload protection. EcoFlow takes no responsibilities for any device failures or data losses caused by failures to follow instructions.

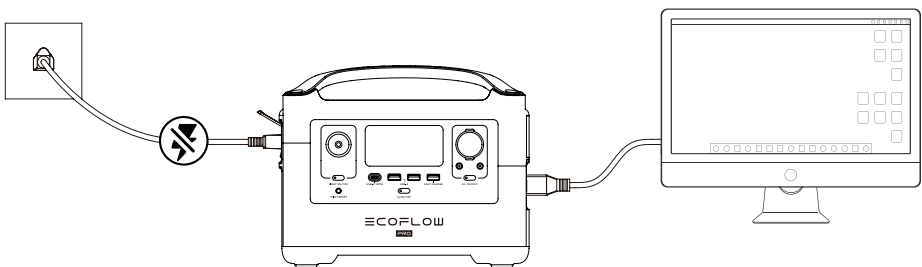

3.10 Extra Battery Connection

Get the RIVER Pro , RIVER Pro Extra Battery and Expansion Power Cable ready. Power off both the RIVER Pro and RIVER Pro Extra Battery before attempting to connect them together. If the products are not turned off, they cannot be successfully connected. Then follow the steps below.

1. Open the Expansion Port cover below the AC port of the RIVER Pro to access the Expansion Power Port. Connect the Expansion Power Cable to the port. Tighten the screws on both sides of the port to secure the connection.
2. Open the Expansion Port cover of the RIVER Pro Extra Battery to access the Expansion Power Port. Connect the free end of the Expansion Power Cable to the RIVER Pro Extra Battery Expansion Power Port. Tighten the screws on both sides of the port to secure the connection.
3. Turn on the power button of the RIVER Pro or RIVER Pro Extra Battery. If the display of the RIVER Pro shows the extra battery icon, the connection is successful. Fully charge the products for the first time and ensure the voltage is consistent to maximize the performance.

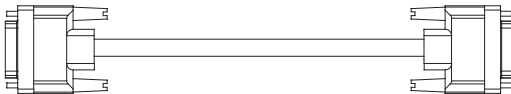
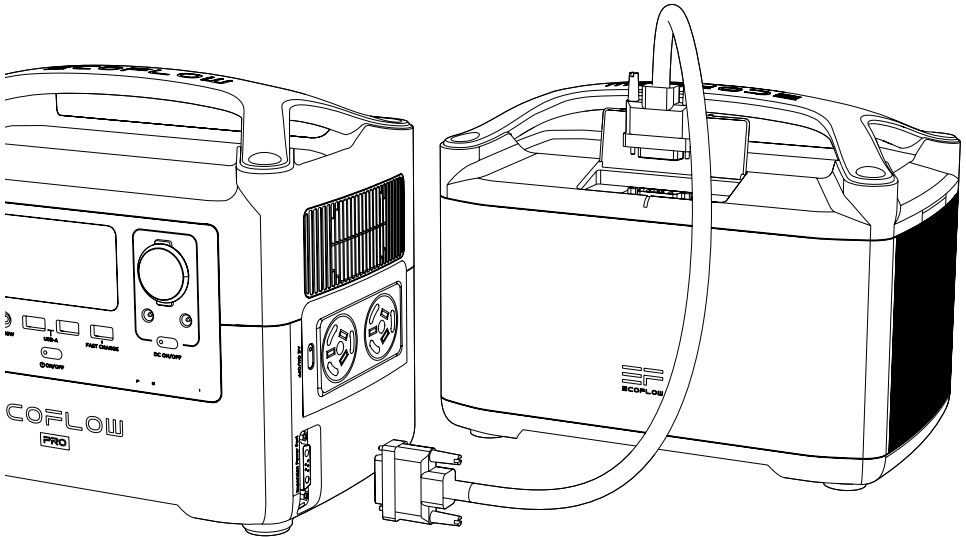

Expansion Power Cable

* Not included in the package, this cable only comes with RIVER Pro Extra Battery

4. FAQs

1. What battery does the product use?

It uses high-quality lithium-ion battery.

2. What devices can the product's AC output port power?

With 600W rated power and 1200W peak power, the product's AC output port can power most household appliances. Before you use it, we recommend that you confirm the power of the appliances first and ensure the power sum of all loaded appliances is lower than the rated power.

3. How long can the product charge my devices?

The charging time is shown on the product's LCD Screen, which can be used to estimate the charging time of most appliances with stable power usage.

4. How can I know if the product is charging?

When it's charging, the remaining charging time will be shown on the LCD Screen. Meanwhile, the charging indicator icon begins to rotate with the remaining battery percentage and the input power shown on the right of the circle.

5. How to clean the product?

Please gently wipe it with a dry, soft, clean cloth or paper towel.

















6. How to store the product?

Before storing, please turn off the product first, and then store it in a dry, ventilated place at room temperature. Do not place it near water sources. For long-term storage, please discharge the battery to 30% and recharge it to 60% every three months to extend its battery life.

7. Can I bring the product on a plane?

No.

5. Troubleshooting

Indicator		Problem	Solution	
RECHARGING TIME	 	Icons Flash together	High Temperature Charge Protection	Charging can be resumed automatically after the battery cools down.
	 	Icons Flash together	High Temperature Discharge Protection	The power supply can be resumed automatically after the battery cools down.
RECHARGING TIME	 	Icons Flash together	Low Temperature Charge Protection	Charging can be resumed automatically after battery temperature rises above 5°C(41°F).
	 	Icons Flash together	Low Temperature Discharge Protection	The power supply can be resumed automatically after the battery temperature rises above -12°C(10°F).
	OVERLOAD	Icons Flash together	Overload Discharging Protection	Battery Exclamation and OVERLOAD icons flash together. Disconnect all appliances, restart the RIVER Pro, and add each appliance back in turn. Please note that electrical appliances must be operated within rated power.
	 50Hz	Icons Flash together	AC Output Overload Protection	Normal operation will be resumed automatically after you remove the overloaded device and restart the product. Electrical appliances should be used within rated power. (Refer to X-Boost instructions to get more details about power limitations).
 50Hz		Icons Flash together	AC High Temperature Protection	Please confirm whether the fan inlet and outlet are blocked, if not, normal operation will be resumed automatically after the product temperature drops.
 50Hz		Icons Flash together	AC Low Temperature Protection	Normal operation will be resumed automatically after the product is used at optimum environmental temperatures.
		Icon Flashes	Fan Blockage	Please check if the fan is blocked by foreign materials.
⊙Car	OVERLOAD	Icons Flash together	Car Charger Overload Protection	The product will resume normal operation automatically after you remove the device connected to the car charger.
⊙Car		Icons Flash together	Car Charger High Temperature Protection	After the product cools down, it will resume normal operation automatically.
		Icon Stays On	Battery Failure	Contact EcoFlow Customer Service

If the Alarm Prompt shows on the product LCD screen during use and does not disappear after a restart, please stop using it immediately (do not try to charge or discharge).

If you require any other assistance, please contact EcoFlow Customer Service.

6. What's In the Box



RIVER Pro

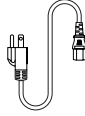

AC Charging Cable (1.5m)

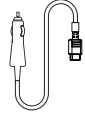

Car Charging Cable
(1.5m)

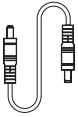

DC5521-DC5525
Cable

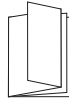

User Manual and
Warranty Card

7. Storage & Maintenance

1. Ideally, use and store the product between 20°C to 30°C (68°F to 86°F), and always keep it away from water, intense heat, and sharp objects. Do not store in temperatures above 45°C (113°F) or below -10°C (14°F) for an extended period.
2. Storing a battery with a low charge for a long period shortens its lifespan. This product mitigates the damage by putting the battery into hibernation mode. To get the most out of the battery, make sure it is about 60% before putting this product into long-term storage, and then once every three months, discharge the battery to 30% and recharge it back to 60%.

≡COFLOW